



VIBRATION ANALYZER



Vibration Analyzer VA-12



Portable vibration analyzer for Equipment Diagnosis and On-site Measurements

Vibration Meter VA-12 With FFT analysis function



Piezoelectric Accelerometer PV-57I (with integrated preamplifier)

Magnet attachment (supplied)

Compact & Lightweight

Vibration Analyzer VA-12

Major Application Fields

Product Development	Vibration measurement at various stages of product development
Quality Assurance	Pre-shipment testing, post-installation operation checks
Maintenance	Startup testing after periodic maintenance and servicing
Simple Diagnosis	Daily routine checks and monitoring of unusual vibration conditions
Precision Diagnosis	Measurement of problem vibrations and detection of fault sources

Vibration Meter Mode

- Allows simultaneous measurement of acceleration, velocity, displacement, and acceleration crest factor



Vibration meter mode

Menu Mode

The crisp color TFT display (240 x 320 dots) is easy to read, whether outdoors, indoors, or in a dark location.



Menu

FFT Analyzer Mode

- Real-time analysis frequency 20 kHz
- Time waveform display and spectrum display with up to 3 200 spectral lines. Envelope processing also supported.
- Vibration waveform data recording function (10 seconds at analysis frequency 20 kHz). Data stored in WAVE file format on memory card (SD card).
- Timer controlled automatic measurement

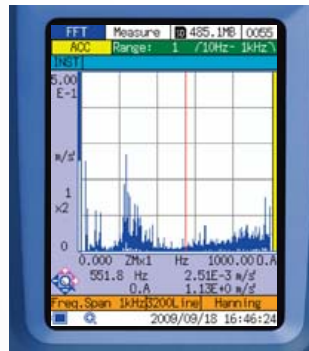

Spectrum display (3 200 lines)

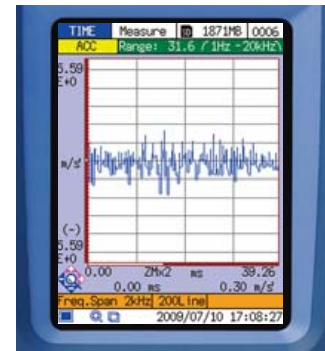

Time waveform display

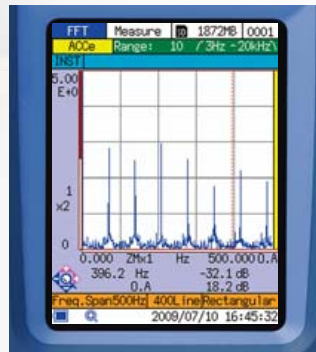

Spectrum after envelope processing

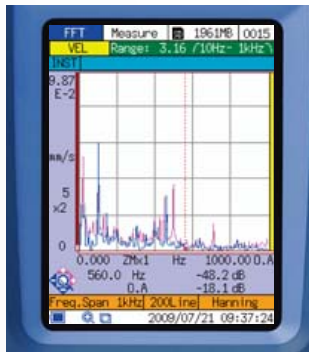

Overlapping of stored data

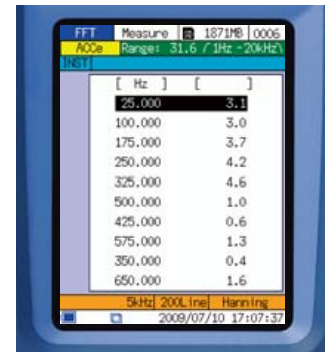

List display (top 10)

USB port allows use of unit as removable disk

Bottom view

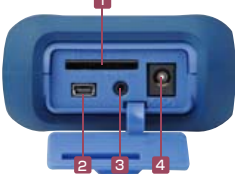

- 1 SD card slot
- 2 USB port
- 3 Trigger input connector
- 4 AC adapter connector

SD cards used as memory media

Measurement data and setting data can be stored as a set on memory cards. Up to 1 000 data sets per store name are supported (max. 100 store names).



System Diagram

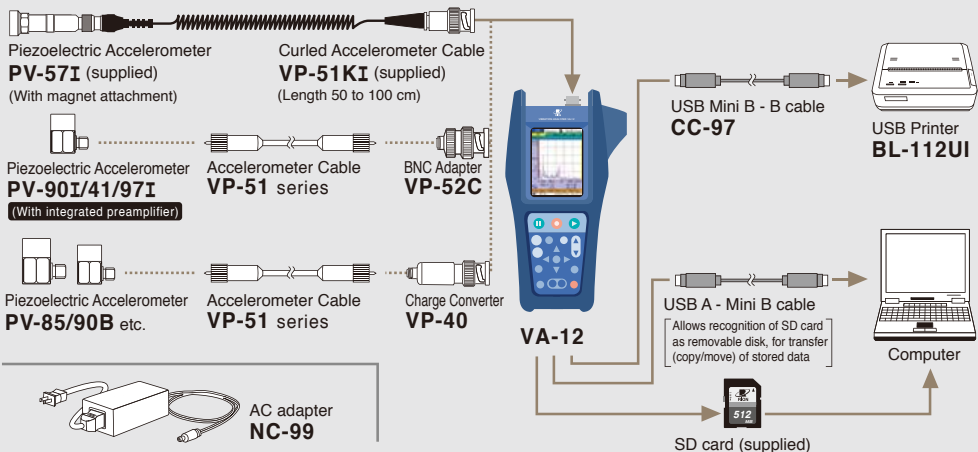

Vibration Meter Mode

Displacement / Acceleration / Velocity Simultaneous Measurement of Three Components



Vibration explained

Mechanical vibrations can be represented as a complex combination of a spring and weight, as shown in the illustration on the right. The basic physical quantities that define vibration are displacement, velocity, and acceleration. By measuring each of these values, the vibration condition can be assessed.

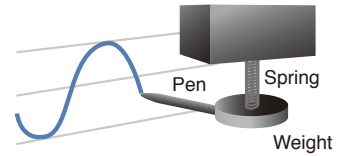

Displacement explained

Unit : μm , mm, etc.

The movement distance (travel) from a reference point is called displacement. For example, if a car travels a distance of 100 meters, the displacement value is 100 m. When considering vibrations, the movement distance of the vibrating object from the stationary rest position is the displacement, which changes between positive and negative values.



Velocity explained

Unit : mm/s, m/s, etc.

This quantity expresses the amount of change per unit of time. It is related to the vibration energy.

For example, if a car travels a distance of 100 meters in 10 seconds, the velocity is the distance (100 m) divided by the time (10 s), i.e. 10 m/s. When considering vibrations, the displacement magnitude and direction change over a short span of time, and the velocity therefore is not usually constant.

The following relationship exists:

Velocity = displacement $\times 2\pi \times$ vibration frequency



Acceleration explained

Unit : m/s^2 , mm/s^2 , etc.

Acceleration is the change in velocity per unit of time.

It is proportional to the impact force or other external force.

For example, if a car traveling at a velocity of 10 m/s changes to a velocity of 30 m/s over a period of 2 seconds, the acceleration is the change in velocity (20 m/s) divided by the time (2 s), i.e. 10 m/s^2 . When considering vibrations, the velocity and direction change over a short span of time, and the acceleration therefore is not usually constant.

The following relationship exists:

Acceleration = velocity $\times 2\pi \times$ vibration frequency



Usage of displacement, velocity, and acceleration

Displacement

- Measurement of vibrations in a low frequency range (below 200 Hz)
- Cases where displacement as such is critical
- Assessment of wear and damage related to static deformation, such as the effects of tensile force or compression
- Assessment of contact risks and machining precision

Velocity

- Measurement of vibrations in a medium frequency range (10 Hz to 1 kHz)
- Detection of imbalance, misalignment, bolt loosening, rattle and play etc.
- Assessment of vibration severity (ISO 10816, JIS B 0906)
- Assessment of metal fatigue

Acceleration

- Measurement of vibrations in a high frequency range (above 1 kHz)
- Detection of bearing and gear defects etc.

Values used to express vibration magnitude

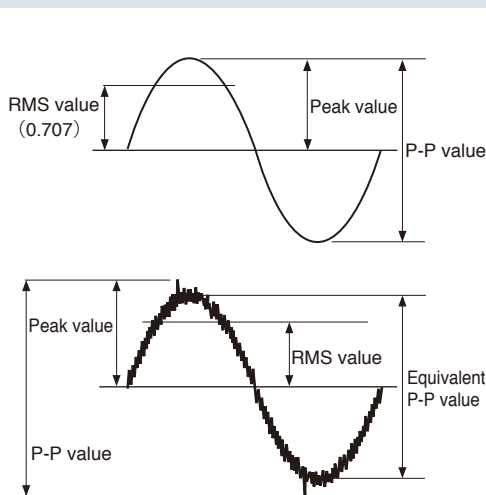

- Peak value.....Maximum value of single-sided amplitude
- RMS value.....Root mean square of instantaneous value
- P-P value(peak-to-peak value)
...Maximum difference between highest and lowest value
- Equivalent peak value.....RSM value multiplied by $\sqrt{2}$
- Equivalent P-P valueRSM value multiplied by $2\sqrt{2}$
- Crest factor.....Peak value/RMS value

Vibration Meter Mode Applications

Simple Diagnosis

Vibration magnitude

Measuring the magnitude of vibrations is a useful diagnostic technique for ascertaining that machinery is operating normally and checking for signs of possible problems.

For example, when vibrations exceeding the reference value in the velocity range (up to 1000 Hz) are detected, the presence of an imbalance, misalignment, or loosening condition can be suspected, whereas vibrations in the acceleration range (1 kHz to about 12 to 15 kHz) point to possible bearing or gear problems.

Crest factor

The crest factor (C.F.) is an indication of the impact characteristics of a waveform. It is determined by the ratio between the RMS and peak values. Higher crest factor values indicate a stronger impact quality.

The crest factor of acceleration measurements is useful for detecting the early stages of bearing damage.

$$\text{Crest factor} = \frac{\text{Peak value}}{\text{RMS value}}$$

The vibration waveform of a bearing with a fault in the initial stage is shown in the example below. Compared to the waveform of a normal bearing, the crest factor is higher.



Normal bearing

(Peak value / RMS value = crest factor is small)

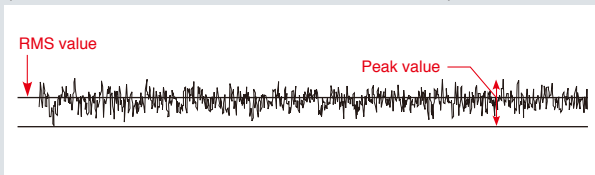

Bearing with spot damage

(Peak value / RMS value = crest factor is large)

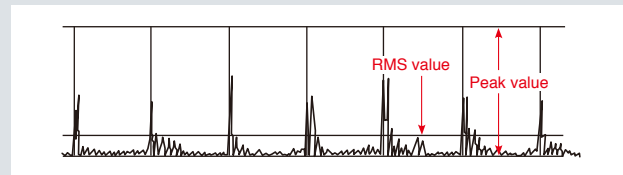

Maintenance Management of Machine Equipment Periodic vibration measurement serves to detect problems.

Using an absolute evaluation standard

ISO 10816-1 (JIS B 0906 Mechanical Vibration – Evaluation of Machine Vibration by Measurements on Non-Rotating Parts)

This is an absolute reference that can be used to judge whether measured vibration data are normal or not. The vibration velocity RMS values are used.

《Definition of classes》

- Class I : Small motors from 0 to 15 kW
- Class II : Motors from 15 to 75 kW, machinery equipment up to 300 kW mounted on a rigid base
- Class III : Large machinery equipment mounted on a rigid base
- Class IV : Large machinery equipment mounted on a flexible base

Representative zone values

Class boundary value (mm/s)	Class I	Class II	Class III	Class IV
— 0.28	A	A	A	A
— 0.45				
— 0.71	B	B	B	B
— 1.12				
— 1.8	C	C	C	C
— 2.8				
— 4.5	D	D	D	D
— 7.1				
— 11.2				
— 18.0				
— 28.0				
— 45.0				

A : Excellent	B : Good	C : Fair	D : Poor
Condition is normal, no action required.	Condition is close to normal, no action required, but monitoring required.	Close monitoring required, repair action may be required soon.	Condition is hazardous, immediate action required.

Using a relative evaluation standard (trend management)

Using the normal condition as a reference, threshold values for caution and hazard conditions are set.

When the caution level is exceeded, monitoring is reinforced, and detailed diagnosis is performed when the hazard level is exceeded. A commonly used factor for setting the levels is as follows: caution level = 2 to 3 times the normal value, hazard level = 2 to 3 times the caution value.

After deciding on the vibration measurement location, measurement direction, and measurement frequency, a time series graph is commonly used for trend management, comprising measurement values and other data.

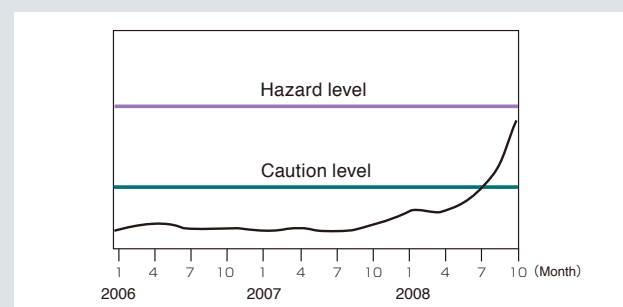

Trend management diagram

FFT Analyzer Mode

The Need for Frequency Analysis

Machinery usually comprises a variety of vibration sources such as motors, gears, bearings, fans, etc. When devising measures to minimize vibrations and when trying to locate the causes of problematic vibrations, measuring only the magnitude of vibrations often will not provide enough information. It is also necessary to perform frequency analysis, in order to determine which types of vibrations exist and what their levels are.

As shown in the illustration, the locations where vibrations occur will affect the vibration frequency. Frequency analysis makes it possible to pinpoint vibration sources with greater accuracy.

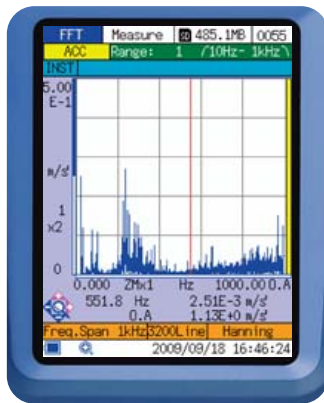
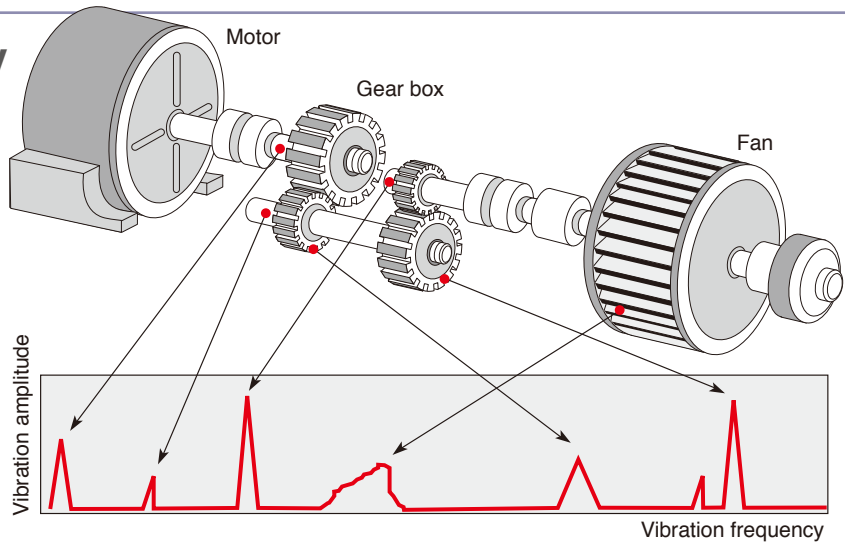

Spectrum

Vibration amplitudes are shown for each frequency. The time waveform is divided into constant intervals, and FFT analysis* is performed for these intervals. A sine wave will have only one line spectrum, but complex machine vibrations will show peaks at various frequencies.

* FFT (Fast Fourier Transform) analysis is a type of frequency analysis that is particularly suited to analyzing machine vibrations.

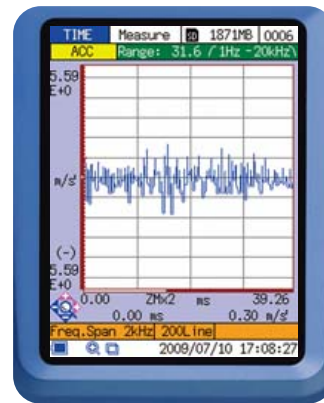

Time Waveform

This shows the variations over time at the location of the accelerometer. It provides information that is not available from the spectrum display, such as whether the vibration is normal or impact related, whether it has shifted upwards or downwards, etc.

FFT Analyzer Mode Applications

Product Quality Control

When testing products on manufacturing lines for unusual vibrations, frequency analysis can be very helpful. For example, when targeting a specific frequency, it can be determined whether there are vibration components in the adjacent frequency range. Using the frequency spectrum with a known good product as reference, comparative analysis can be applied to pass / fail evaluation.

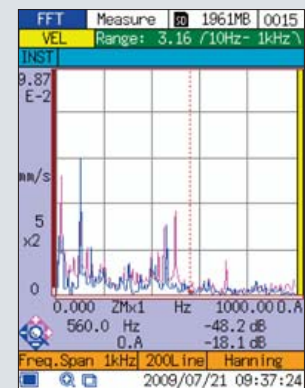
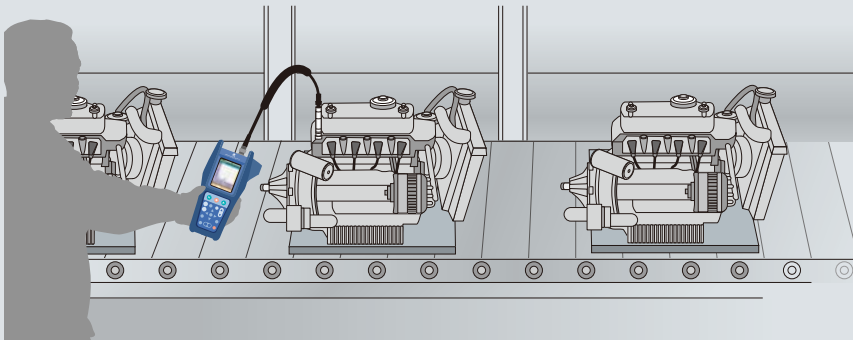

Comparison to reference spectrum
(Overlapping of stored data)

FFT Analyzer Mode Applications

Precision Diagnosis of Rotating Machinery

Precision diagnosis is used to determine the cause of problems as well as the extent, location etc.

Bearings

Bearing problems will cause a significant increase in acceleration values. As seen in the example, envelope analysis shows the peaks at equal intervals. When the size, number of rolling elements, axis rotation speed and other parameters are known, the primary frequency of the lined-up peaks will provide information about the problem location.

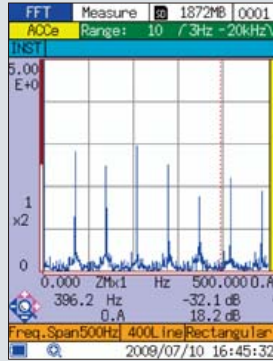

When diagnosing a bearing fault, it is necessary to know the repeat cycle of the impact waveform. This can be achieved by envelope processing, using the principle illustrated below.

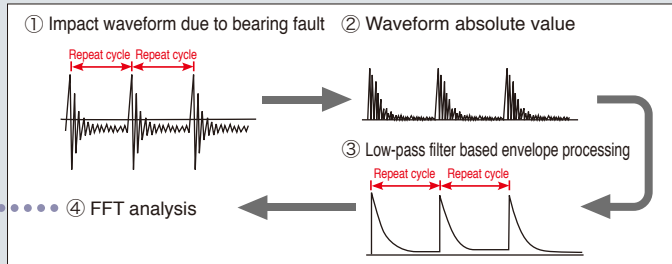

Misalignment

When there is a misalignment, large vibration components that are an integral multiple of the rotation speed will appear in the axis direction. The type of bearing joint affects the multiplication factor. In the example shown here, there are large vibration components with a factor of 3.

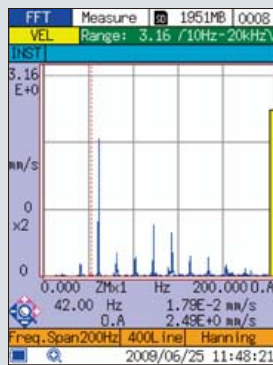

Misalignment explained

When two coupled rotating axes are not properly centered on relation to each other, their centers of rotation will not be in linear alignment. This is called misalignment, which can be either relative to the core or the face or a combination of the two. When misalignment occurs, the thrust load on the bearing increases due to end face runout, resulting in shorter bearing life.

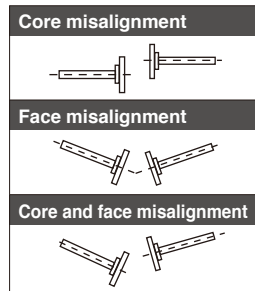

Imbalance

When there is an imbalance, large vibration components at a frequency equal to the rotation speed will appear in the circumferential direction. Vibrations of other frequencies will be largely absent. The vibration amplitude is proportional to the imbalance magnitude. At higher rotation speeds, the vibration amplitude is proportional to the square of the rotation frequency.

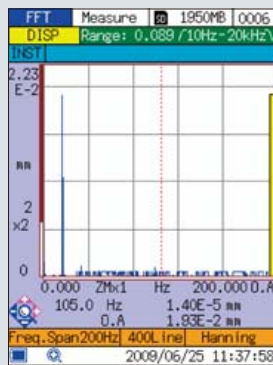

Imbalance explained

This is a condition where the center of gravity of a rotating body has shifted from the center line. There are various types of imbalance, including static imbalance, couple imbalance, and dynamic imbalance. When an imbalance occurs, the load on the bearing in the circumferential direction increases, resulting in shorter bearing life.

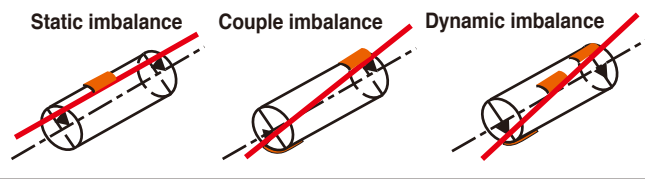

Measuring the Resonance Frequency of a Structure

When an external force at a frequency close to the resonance frequency is applied to a structure, strong vibration will occur. This can lead to breakdown of machinery, product quality degradation, and other problems. In order to guard against such risks, measuring the resonance frequency is very important. In the example shown at right, multiple resonance frequencies at 8 Hz, 98 Hz etc. exist.

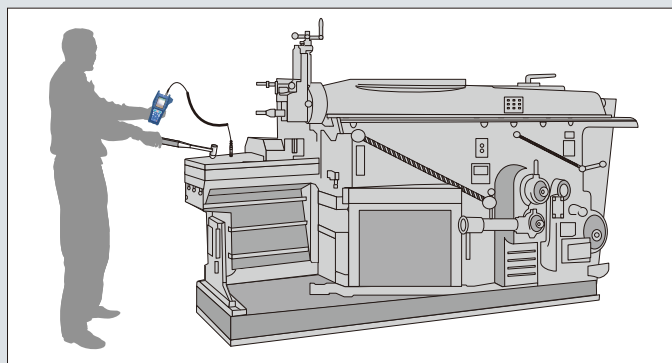
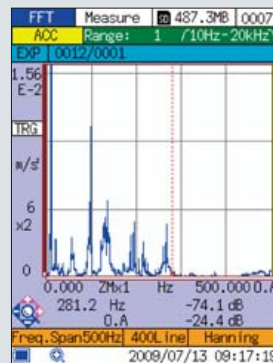

To measure the resonance frequency, the structure is struck with a hammer or similar and the resulting vibrations are subject to frequency analysis.

Specifications

Standard compliance	CE marking (EMC Directive 2004/108/EC) Chinese RoHS (export model for China only) WEEE Directive
Input section	
Number of measurement channels	1
Connector type etc.	BNC, CCLD 18 V 2 mA, (CCLD24 V 4 mA available as factory option)
Sensor	Piezoelectric Accelerometer PV-571 (supplied)
Input range	
At sensitivity 0.100 to 0.999 mV/(m/s ²)	
ACC (Acceleration)	10, 31.6, 100, 316, 1 000, 3 160, 10 000 m/s ² (rms)
VEL (Velocity)	31.6, 100, 316, 1 000, 3 160, 10 000, 31 600 mm/s (rms)
DISP (Displacement)	0.89, 2.83, 8.94, 28.3, 89.4, 283, 894 mm (EQ-p)
At sensitivity 1.00 to 9.99 mV/(m/s ²), using PV-571	
ACC (Acceleration)	1, 3.16, 10, 31.6, 100, 316, 1 000 m/s ² (rms)
VEL (Velocity)	3.16, 10, 31.6, 100, 316, 1 000, 3 160 mm/s (rms)
DISP (Displacement)	0.089, 0.283, 0.894, 2.83, 8.94, 28.3, 89.4 mm (EQ-p)
At sensitivity 10.0 to 99.9 mV/(m/s ²)	
ACC (Acceleration)	0.1, 0.316, 1, 3.16, 10, 31.6, 100 m/s ² (rms)
VEL (Velocity)	0.316, 1, 3.16, 10, 31.6, 100, 316 mm/s (rms)
DISP (Displacement)	0.0089, 0.0283, 0.0894, 0.283, 0.894, 2.83, 8.94 mm (EQ-p)
Measurement range (using PV-571, High-pass filter 3 Hz, Low-pass filter 20 kHz)	
ACC (Acceleration)	0.02 to 141.4 m/s ² (rms) Continuous measurement, 1 Hz to 5 kHz
Instantaneous maximum acceleration	700 m/s ²
VEL (Velocity)	0.2 to 141.4 mm/s (rms) at 159.15 Hz
DISP (Displacement)	0.02 to 40.0 mm (EQ-p) at 15.915 Hz
Measurement frequency range (electrical characteristics)	
ACC (Acceleration)	1 Hz to 20 kHz
VEL (Velocity)	3 Hz to 3 kHz
DISP (Displacement)	3 Hz to 500 Hz
Acceleration envelope curve	1 kHz to 20 kHz
Filters	
Prefilters	
High-pass filter	1 Hz (acceleration only), 3 Hz, 10 Hz, 1 kHz (-10 % point), cutoff slope -18 dB/oct
Low-pass filter	1 kHz, 5 kHz, 20 kHz (-10 % point), cutoff slope -18 dB/oct
Acceleration envelope curve filter	
High-pass filter	1 kHz (-10 % point), cutoff slope -18 dB/oct
Inherent noise	High-pass filter 3 Hz, Low-pass filter 20 kHz, lowest range setting
ACC (Acceleration)	0.01 m/s ² (rms) or less
VEL (Velocity)	0.1 mm/s (rms) or less
DISP (Displacement)	0.01 mm (EQ-p) or less
A/D conversion	24 bit $\Delta\Sigma$ principle, 51.2 kHz
Dynamic range	Maximum 110 dB (Acceleration)
Vibration meter mode	
ACC (Acceleration)	m/s ² rms value, waveform peak value, crest factor
VEL (Velocity)	mm/s rms value
DISP (Displacement)	mm EQ-p
FFT mode	Time waveform, spectrum, Acceleration envelope curve
Analysis points	512, 1 024, 2 048, 4 096, 8 192 (3 200 lines)
Time window functions	Rectangular, Hanning, flat-top
Processing	Linear average, maximum, exponential averaging, instantaneous value
Frequency span	100 Hz, 200 Hz, 500 Hz, 1 kHz, 2 kHz, 5 kHz, 10 kHz, 20 kHz
Display	
Spectrum	Top 10 list, graph display (excluding DC)
Zoom	X axis : x1, x2, x4, x8, x16 Y axis : 2 ^N , N = 0 to 10 (x1 to x1 024)
Overlay display with stored data in spectrum mode	
Time wave form	Graph display
Zoom	X axis : x1, x2, x4, x8, x16, x32 Y axis : 2 ^N , N = 0 to 14 (x1 to x16 384)
Trigger	
Trigger source	
External signal	Triggered at falling edge of signal at external trigger input
Input level	Triggered when time waveform crosses a preset level Trigger level can be set in steps of 1/8 of full scale on one-sided amplitude
Slope	+/- trigger operation
Trigger operation	
Free-run	Processing always carried out, regardless of trigger condition
Repeat	Processing carried out whenever triggering occurs
Single	Processing carried out once only when triggering occurs
Time	Data are stored according to the setting of Trigger Start Time, Store Interval, Store number.

Pretrigger	Processing starts from data 1/8 frame time ahead
Display	Color TFT LCD, 240 x 320 dots, with backlight Japanese display, English display, Time display
Warning indication	LED (lights up in red to indicate overload)
Memory	
Memory media	SD cards (max. 2 GB)*
Store files	Sets of measurement values and parameters can be stored on memory card 1 000 data saved as one store name. Max. number of store names: 100
Parameter setting memory	Up to 5 parameter sets can be stored in unit Parameter settings can be stored on memory card
Wave files	Up to 10 seconds per file (frequency range 20 kHz) Vibration waveform recorded during FFT processing available when using a computer.
BMP files	Screen capture can be saved as BMP files.
Recall function	Measurement data can be read from memory card and redisplayed on screen.
Resume function	Settings are memorized when power is turned off and can be restored at next power-on
Input/output section	
Trigger input connector	TTL level, ultra mini jack, 2.5 mm dia. (for CC-24)
USB port	Removable disk function Allows use of memory card inserted in unit as removable storage device (removable storage device class)
Printer function	Dedicated USB printer (BL-112UI) can be used for printing, screen hard copy, and continuous printing of specified memory address range
Power	
DC12 V (11 to 15 V)	AC adapter NC-99, eight IEC R6 (size AA) batteries (23°C, normal operation, backlight off)
Battery life	Approx. 12 hours
Current consumption	145 mA (normal operation, backlight off)
Ambient temperature and humidity conditions for use	-10 to +50 °C, 90 % RH or less (no condensation)
Dimensions, Weight	214 (H) x 105 (W) x 36 (D) mm; Mass Approx. 850 g (incl. batteries, with protective cover, PV-571 connected)
Supplied accessories	Piezoelectric Accelerometer PV-571, Curled cable, Magnet attachment IEC R6 (size AA) battery x 8, SD card, Protective cover, Shoulder belt

Option

Name	Model
Waveform Analysis Software	CAT-WAVE
Piezoelectric accelerometer	Various
BNC Adapter	VP-52C
Charge converter	VP-40
SD-CARD 512 MB*	SD-512M
SD-CARD 2 GB*	SD-2G
BNC-mini plug Cable	CC-24
AC Adapter	NC-99
USB Printer	BL-112UI
Thermal Printer Paper (10 rolls)	P-112-30
USB Mini B-B Cable (for Printer connection)	CC-97

*Use only RION supplied cards for assured operation

Option

Waveform Analysis Software CAT-WAVE

CAT-WAVE allows post-processing using stored waveform file data from VA-12

- Waveform display functions: Scaled time axis, Differential and integral calculus available
- Display functions of FFT analysis: Power spectrum, Cross spectrum, Transfer function, Coherence, Power spectrum map, Octave map, Differential and calculus for spectrum area
- Octave band analysis: Analysis frequency ranges: 1/1 octave 0.5 Hz to 8 kHz (15 bands), 1/3 octave 0.4 Hz to 10 kHz (45 bands), 1/12 octave 0.36 Hz to 11 kHz (180 bands)
Time weighting (time constants): 1 ms, 10 ms, 35 ms, F (Fast), 630 ms, S (Slow), 10 s
Frequency weighting: Flat, A, C

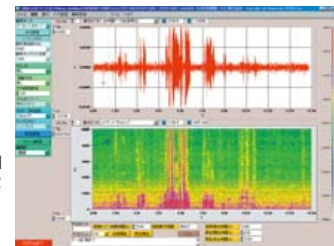

* Specifications subject to change without notice.

Distributed by:

 **RION CO., LTD.**
http://www.rion.co.jp/english/

3-20-41, Higashimotomachi, Kokubunji, Tokyo 185-8533, Japan
Tel: +81-42-359-7888 Fax: +81-42-359-7442

 This product is environment-friendly. It does not include toxic chemicals on our policy.
This leaflet is printed with environmentally friendly soy ink on recycled paper.

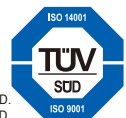

ISO 14001 RION CO., LTD.
ISO 9001 RION CO., LTD.