

DSX-PCxx

Patch Cord Adapters

Users Manual

LIMITED WARRANTY AND LIMITATION OF LIABILITY

Each Fluke Networks product is warranted to be free from defects in material and workmanship under normal use and service unless stated otherwise herein. The warranty period for the mainframe is one year and begins on the date of purchase. Parts, accessories, product repairs and services are warranted for 90 days, unless otherwise stated. Ni-Cad, Ni-MH and Li-Ion batteries, cables or other peripherals are all considered parts or accessories. The warranty extends only to the original buyer or end user customer of a Fluke Networks authorized reseller, and does not apply to any product which, in Fluke Networks' opinion, has been misused, abused, altered, neglected, contaminated, or damaged by accident or abnormal conditions of operation or handling. Fluke Networks warrants that software will operate substantially in accordance with its functional specifications for 90 days and that it has been properly recorded on non-defective media. Fluke Networks does not warrant that software will be error free or operate without interruption.

Fluke Networks authorized resellers shall extend this warranty on new and unused products to end-user customers only but have no authority to extend a greater or different warranty on behalf of Fluke Networks. Warranty support is available only if product is purchased through a Fluke Networks authorized sales outlet or Buyer has paid the applicable international price. To the extent permitted by law, Fluke Networks reserves the right to invoice Buyer for repair/replacement when a product purchased in one country is submitted for repair in another country.

For a list of authorized resellers, visit www.flukenetworks.com/wheretobuy.

Fluke Networks warranty obligation is limited, at Fluke Networks option, to refund of the purchase price, free of charge repair, or replacement of a defective product which is returned to a Fluke Networks authorized service center within the warranty period.

To obtain warranty service, contact your nearest Fluke Networks authorized service center to obtain return authorization information, then send the product to that service center, with a description of the difficulty, postage and insurance prepaid (FOB destination). Fluke Networks assumes no risk for damage in transit. Following warranty repair, the product will be returned to Buyer, transportation prepaid (FOB destination). If Fluke Networks determines that failure was caused by neglect, misuse, contamination, alteration, accident or abnormal condition of operation or handling, or normal wear and tear of mechanical components, Fluke Networks will provide an estimate of repair costs and obtain authorization before commencing the work. Following repair, the product will be returned to the Buyer transportation prepaid and the Buyer will be billed for the repair and return transportation charges (FOB Shipping point).

THIS WARRANTY IS BUYER'S SOLE AND EXCLUSIVE REMEDY AND IS IN LIEU OF ALL OTHER WARRANTIES, EXPRESS OR IMPLIED, INCLUDING BUT NOT LIMITED TO ANY IMPLIED WARRANTY OF MERCHANTABILITY OR FITNESS FOR A PARTICULAR PURPOSE. FLUKE NETWORKS SHALL NOT BE LIABLE FOR ANY SPECIAL, INDIRECT, INCIDENTAL OR CONSEQUENTIAL DAMAGES OR LOSSES, INCLUDING LOSS OF DATA, ARISING FROM ANY CAUSE OR THEORY.

Since some countries or states do not allow limitation of the term of an implied warranty, or exclusion or limitation of incidental or consequential damages, the limitations and exclusions of this warranty may not apply to every buyer. If any provision of this Warranty is held invalid or unenforceable by a court or other decision-maker of competent jurisdiction, such holding will not affect the validity or enforceability of any other provision.

Contents

Title	Page
Introduction	1
Kit Contents	1
DSX-PC5ES	1
DSX-PC6S	1
DSX-PC6AS	1
Contacting Fluke Networks	2
Additional Resources for Cable Testing Information	2
⚠ Safety Information	2
DSX Software Requirements	3
Characterize the Performance of the Adapters	3
How to Do Tests on Patch Cords	3
How to Set Up the Tester	3
How to Do the Patch Cord Test	5
Patch Cord Test Results	6
Why Patch Cords Fail	6
Wire Map Failures	7
Return Loss Failures	7
NEXT Failures	7
Is the Cable Bad or is the Plug Bad?	8
Mechanical Stress Tests for Patch Cords	10
When to Replace the Jacks in the Adapters	10
How to Monitor the Number of Insertions for a Jack	11
How to Order Replacement Jacks	11

Replacement Parts 11

How to Replace the Jacks 12

Specifications 13

Appendix A: How to Characterize and Verify the Adapters' Performance .. 15

Introduction

The DSX-PCxx Patch Cord Adapters let you use a DSX CableAnalyzer™ tester to make sure that patch cords comply with ANSI/TIA and ISO/IEC standards. The adapters have RJ45 jacks that Fluke Networks selects specifically for tests on Cat 5e and 6 patch cords as specified in TIA-568-C.2 and IEC 61935-2, and Cat 6_A patch cords as specified in IEC 61935-2.

Note

Standards organizations can add amendments to standards. Contact the applicable standards organization for details. For general information on standards and for DSX software updates that include updated standards, contact Fluke Networks.

Kit Contents

A DSX-PCxxS Patch Cord Adapter Set comes with these items:

DSX-PC5ES

- Two DSX-PC5E Cat 5e Patch Cord Adapters
- DSX-PCxxS Product Manuals CD-ROM

DSX-PC6S

- Two DSX-PC6 Cat 6 Patch Cord Adapters
- DSX-PCxxS Product Manuals CD-ROM

DSX-PC6AS

- Two DSX-PC6A Cat 6_A Patch Cord Adapters
- DSX-PCxxS Product Manuals CD-ROM

If something is missing or damaged, contact the place of purchase immediately.

Contacting Fluke Networks

Note

If you contact Fluke Networks about your tester, have the tester's software and hardware version numbers available if possible.

 www.flukenetworks.com/support

 info@flukenetworks.com

 1-800-283-5853, +1-425-446-5500

 **Fluke Networks**
6920 Seaway Boulevard, MS 143F
Everett WA 98203 USA

Fluke Networks operates in more than 50 countries worldwide. For more contact information, go to our website.

Additional Resources for Cable Testing Information

For more information on the DSX CableAnalyzer, see the Versiv Series manuals available on the Fluke Networks website.

The Fluke Networks Knowledge Base answers common questions about Fluke Networks products and provides articles on cable testing techniques and technology.

To access the Knowledge Base, log on to www.flukenetworks.com, then click **SUPPORT > Knowledge Base**.

Safety Information

Warning

To prevent possible fire, electric shock, personal injury, damage to equipment, or inaccurate test results, read the safety information in the Versiv Series manuals before you use the tester.

DSX Software Requirements

The DSX main and remote testers need Versiv software version 2.3 or later to do tests with the DSX-PCxx adapters.

To see the software versions in your main and remote testers

- 1 Connect the main and remote testers together with permanent link and channel adapters or two channel adapters and a patch cord.
- 2 Turn on both testers.
- 3 On the main tester tap **TOOLS**, then **Version Information**.

The latest DSX software version is available at no charge on the Fluke Networks web site. Download the update file from the website, then use LinkWare™ software to install new software into the DSX testers. See the Versiv Series manuals or the online help in LinkWare for instructions.

Characterize the Performance of the Adapters

When you first get the patch cord adapters, characterize their performance. Later, the test results can help you see if the adapters need new jacks. See Appendix A.

How to Do Tests on Patch Cords

Caution

Testing patch cords that have poorly crimped plugs can reduce the life of the patch cord adapter's jacks or make them unusable.

How to Set Up the Tester

- 1 Attach the DSX-PCxx adapters to the main and remote DSX testers.
- 2 On the home screen, tap the test setup panel.
- 3 On the **CHANGE TEST** screen, tap **NEW TEST**.

-continued-

- 4 On the **TEST SETUP** screen, tap **Cable Type**, then tap the correct cable type, Cat 5e, 6, or 6A.
- 5 On the **TEST SETUP** screen, tap **Test Limit**, then tap the correct patch cord test limit, **Cat7A Patch Cords**, **Cat7 Patch Cords**, **Cat6A Patch Cords**, **Cat6 Patch Cords**, or **Cat5e Patch Cords**.

If you do not see the correct patch cord test limit, tap **MORE**, tap **Patch Cords**, then tap the correct limit.

- 6 The **TEST LIMIT - Patch Cords** screen shows a list of patch cords that have different lengths.

On the **TEST LIMIT - Patch Cords** screen, tap the correct patch cord.

Notes

TIA limits that have "(LA)" in the limit name are used only with DSX Lab Adapters in Fluke Networks service centers.

If the patch cord's length is not in the list, select a limit with the next longest length. For example, if the patch cord is 2.2 m long, select a limit for a 2.5 m patch cord.

- 7 On the **TEST SETUP** screen, select these settings:
 - **Store Plot Data: On**
 - **HDTDR/HDTDx: Fail/Pass* only.** If you want time-domain reflectometry and time-domain crosstalk plots for all the patch cords you test, select **All Autotests**. For more information about the HDTDR and HDTDx tests, see the *Versiv Series Technical Reference Handbook* available on the Fluke Networks website.
 - **Outlet Configuration:** Select the correct wire map for the patch cords.
 - **AC Wire Map: Off (DSX-5000 only)**
- 8 On the **TEST SETUP** screen, tap **SAVE** when your test setup is completed.
- 9 On the **CHANGE TEST** screen, make sure the button next to the test is selected, then tap **USE SELECTED**.
- 10 If you want to make a list of cable IDs or change the **Auto Save** setting, tap the **Next ID** panel on the home screen.

How to Do the Patch Cord Test

Note

For DSX-PC6A adapters: Typically, you can move an RJ45 plug slightly in or out of the jack even when the latch engages. For Cat 6A patch cords, the two positions can give slightly different results for a patch cord test. To help ensure consistent results, specify in your test procedure whether the cords must be pushed in completely or pulled back.

- 1 Connect the patch cord to the main and remote testers, as shown in Figure 1.
- 2 Turn on both testers, then tap **TEST** on the main tester or press  on the main or remote tester.

Note

The main tester will not turn on a remote tester when they are connected through patch cord adapters.

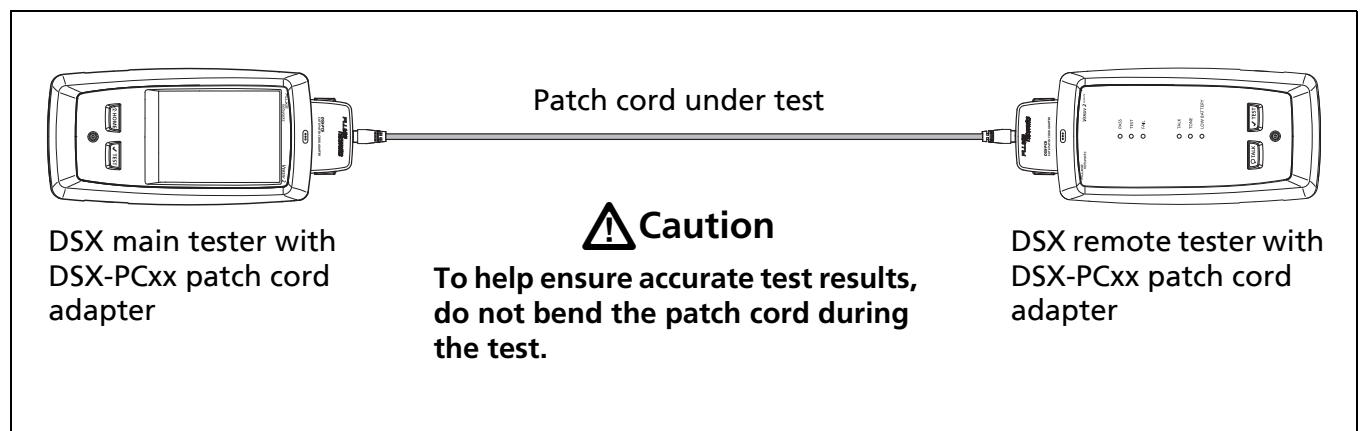

Figure 1. Patch Cord Test Connections

CO1.EPS

Patch Cord Test Results

Patch cord tests evaluate these characteristics:

- Wire map
- Return loss
- NEXT

The patch cord test specifications assume that insertion loss (attenuation), ACR-F (ELFEXT), DC resistance, length, propagation delay, and delay skew requirements are met by the patch cord's design, thus, test limits for these measurements are not required.

Why Patch Cords Fail

Patch cords can fail because of faulty wiring, poor workmanship, poor quality materials, or damage to the cable or plug.

When margins begin to get smaller and failures occur more frequently, your adapters possibly need new jacks. If you characterized the adapters' performance when the adapters were new, use the results and the reference patch cord to evaluate the adapters' performance. See Appendix A.

The sections below give typical causes for wire map, return loss, and NEXT failures.

Wire Map Failures

Wire map failures are typically caused by these problems:

- Wires connected to wrong pins at plug
- Faulty connections
- Damaged plug
- Damaged cable
- Wrong **Outlet Configuration** selected on the **TEST SETUP** screen
- Mix of T568A and T568B wiring standards (1,2 and 3,6 crossed)
- Conductive material stuck between pins at plug

Return Loss Failures

Return loss failures are typically caused by these problems:

- Cable impedance not 100 Ω
- Patch cord handling causing changes in impedance
- Excessive untwisting of pairs at plug
- Poor quality plug
- Cable impedance is not consistent (poor quality cable)
- Distortions in the cable, such as pinches or kinks
- Poorly-matched plug and jack (usually affects Cat 6/Class E applications)
- Wrong test limit selected

NEXT Failures

NEXT failures are typically caused by these problems:

- Wire pairs untwisted too much at the plug. Most NEXT failures occur at plugs, where the wire pairs are untwisted.
- Poor quality plug
- Poor quality cable
- Poorly matched plug and jack
- Distortions in the cable, such as pinches or kinks
- Too much electrical noise near cabling under test.
- Wrong test limit selected

Is the Cable Bad or is the Plug Bad?

You can use the HDTDx and return loss plots to see if a patch cord failed because of bad cable or a plug that is bad or poorly installed. See Figures 2 and 3.

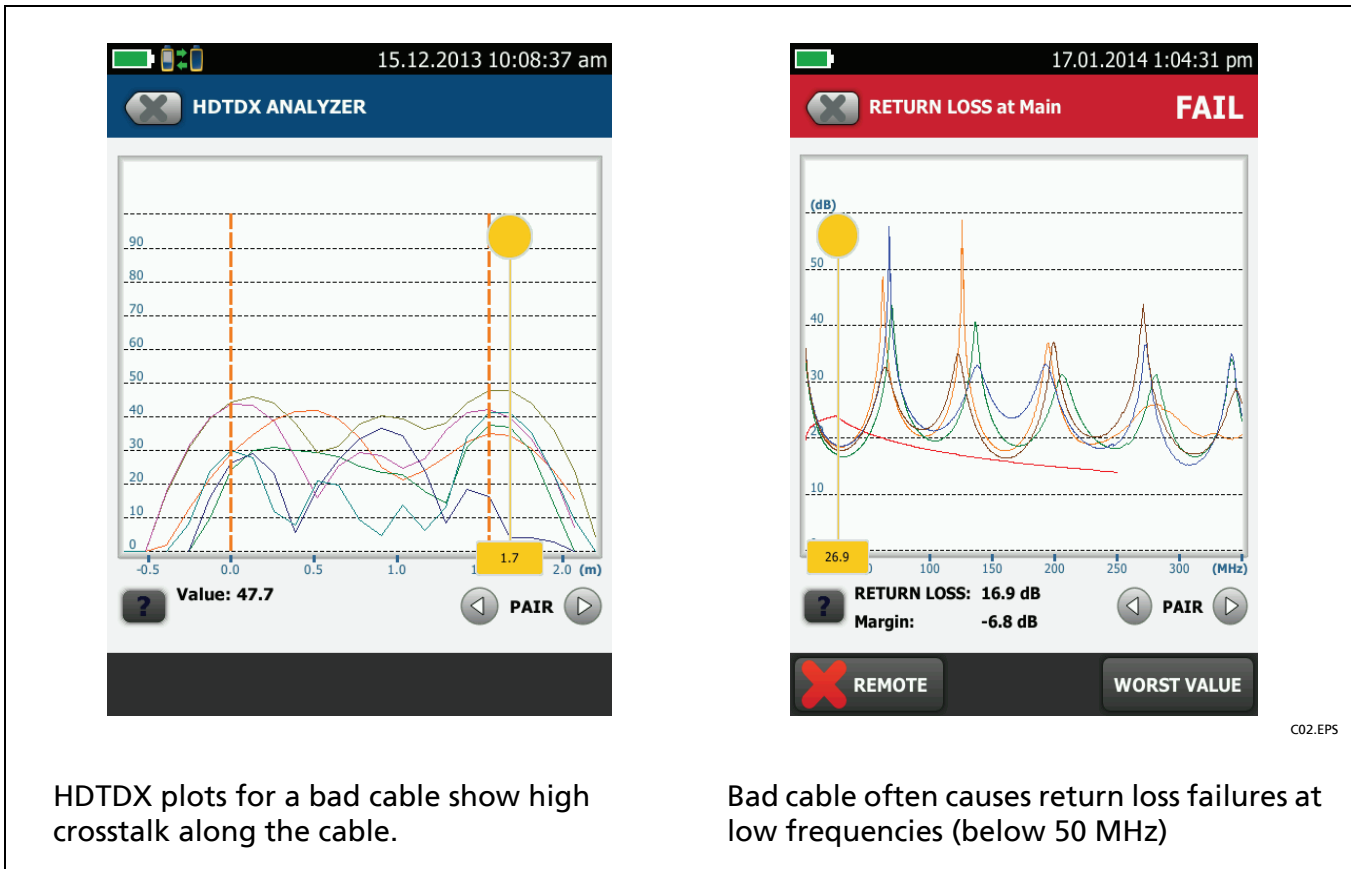
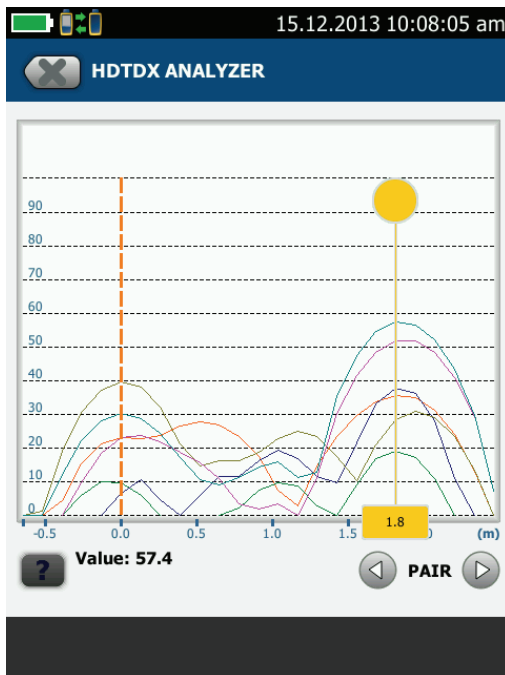
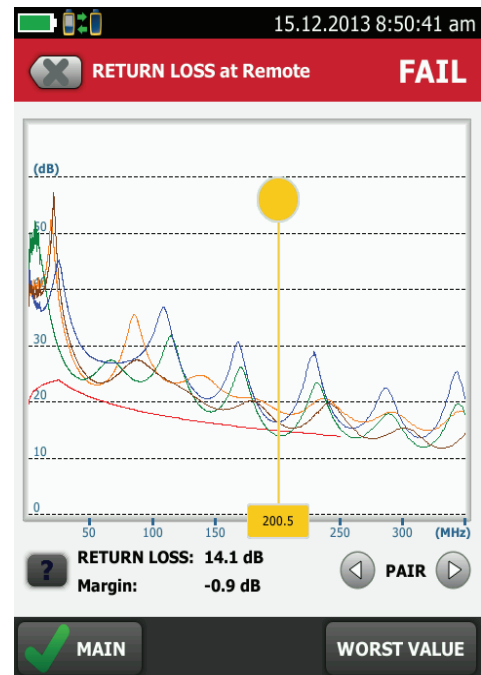

Figure 2. HDTDx and RL Plots for a Bad Cable



HDTDX plots for a bad plug show high crosstalk at the plug.



A bad plug often causes return loss failures at high frequencies. Typically, the test fails or has the worst margin at the end with the bad plug.

Figure 3. HDTDX and RL Plots for a Bad Plug at the Remote

C05.EPS

Mechanical Stress Tests for Patch Cords

Every patch cord design should be evaluated for changes in performance, especially return loss performance, under mechanical stress. Refer to the ANSI/TIA or ISO/IEC standards for more information about stress tests.

Since it is not practical to do the stress tests on every patch cord produced, you can do tests on samples of your patch cords to ensure quality. The sample size depends on the necessary level of quality. Or, you can use the stress tests to see the possible shift in performance, then apply the shift to worst-case margins to make sure that patch cords meet specifications under worst-case conditions. You can apply the shift as you test, or you can use LinkWare software to upload test results to a PC for evaluation.

When to Replace the Jacks in the Adapters

The RJ45 jacks in the DSX-PCxx adapters are typically good for 5000 insertions when used continuously.

When used non-continuously, the lifetime can be reduced to 750 insertions. After 750 insertions, the gold plating that prevents oxidation on the contacts is possibly worn away, but continuous use wipes off the oxidation and extends the life of the contacts.

Caution

If you do tests on patch cords that have poorly crimped plugs, you can reduce the life of the patch cord adapter's jacks or make them unusable.

Replace the jacks in the adapters when any of these conditions occur:

- Margins for patch cord tests begin to get smaller.
- Patch cord tests, especially wire map or return loss tests, begin to give inconsistent results.
- You have connected patch cords to the jacks more than 5000 times.
- The characterization test given in Appendix A fails or the results are very different from the results you saw when the adapters were new.

How to Monitor the Number of Insertions for a Jack

To see the number of tests done with a patch cord adapter, attach the adapter to the main tester, then tap **TOOLS > Version Information > ADAPTER**. These counts show on the **VERSION INFORMATION** screen:

- **Autotest Count** is the number of Autotests done with the adapter.
- **Current Series** is an Autotest count that you can reset. Use this counter to monitor the number of insertions for the jack. To reset the counter after you replace a jack, tap **Reset Series**.

How to Order Replacement Jacks

Table 1 shows the replacement parts available for the DSX-PCxx Patch Cord Adapters. To order replacement jacks, contact Fluke Networks as described on page 2.

Replacement Parts

Table 1. Replacement Parts

Description	Fluke Networks Model Number
Set of two shielded RJ45 Cat 6 _A test jacks	DSX-PCTAC6AKS
Set of two shielded RJ45 Cat 6 test jacks	DSX-PCTAC6KS
Set of two shielded RJ45 Cat 5e test jacks	DSX-PCTAC5EKS
Single DSX-PC6A Cat 6 _A adapter	DSX-PC6A
Single DSX-PC6 Cat 6 adapter	DSX-PC6
Single DSX-PC5E Cat 5e adapter	DSX-PC5E

How to Replace the Jacks



To prevent damage to the adapters and to make sure that your test results are as accurate as possible:

- The DSX-PCxx adapters have static-sensitive components. When you replace the RJ45 jack, obey rules to prevent electrostatic discharge (ESD).
- Replace the jacks only with jacks of the same type. For example, do not put Cat 5e jacks onto Cat 6 circuit boards.
- Do not put stress on the circuit board when you remove or replace the jack.

Note

To ensure reliable operation, replace the DSX-PCxx patch cord adapter after you have replaced the RJ45 jack 10 times.

- 1 Use a TORX PLUS® driver, size T-7, to remove the three screws from the back of the patch cord adapter.
- 2 Take the adapter case apart and remove the circuit board from the case.
- 3 Pull the RJ45 jack off of the circuit board (Figure 4).
- 4 Align the new RJ45 jack on the connectors on the circuit board. See in Figure 4 how the insulation displacement connectors in the jack slide into the connectors on the circuit board.
- 5 Push the RJ45 jack onto the connectors on the board. If firm pressure does not push the jack onto the connectors, realign the jack before you try again.
- 6 Reassemble the case.
- 7 If you want to monitor the number of tests you do with the new jack, reset the **Current Series** count for the adapter. See "How to Monitor the Number of Insertions for a Jack" on page 11.

If you characterized the performance of the adapters before, do the characterization procedure again and save the results as the new characterization results for the adapters. See "How to Characterize the Adapters" on page 15.

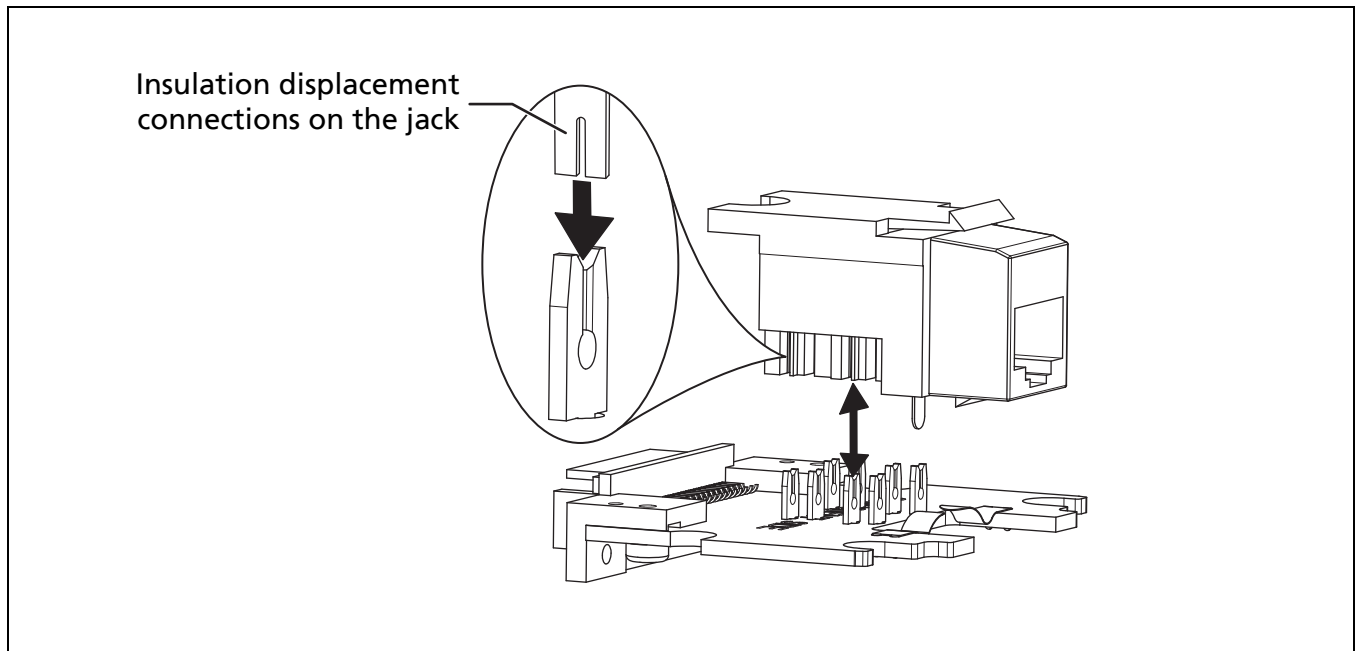

Figure 4. How to Align the RJ45 Jack on the Circuit Board

Specifications

The DSX CableAnalyzer testers and adapters comply with these accuracy requirements at these categories of permanent link and channel pass/fail limits:

- Level IIe requirements at ANSI/TIA and ISO/IEC Cat 5e patch cord test limits.
- Level III requirements at ANSI/TIA and ISO/IEC Cat 6 patch cord test limits.
- Level IIIe requirements at ISO/IEC Cat 6_A patch cord test limits.

For more DSX-PCxx Patch Cord Adapter specifications, contact Fluke Networks.

For DSX CableAnalyzer specifications, refer to the *Versiv Series Technical Reference Handbook* available on the Fluke Networks website.

Appendix A: How to Characterize and Verify the Adapters' Performance

Introduction

This appendix tells how to characterize the performance of the DSX-PCxx adapters. Later, you can do the test again to see if the adapters are operating correctly.

How to Characterize the Adapters

When you first get the patch cord adapters, do this procedure to characterize their performance.

- 1 Attach the DSX-PCxx adapters to the main and remote DSX testers.
- 2 Get several patch cords of the same length that are possibly good.
- 3 On the main DSX tester, select a patch cord test limit that is applicable to the patch cords.
- 4 Do an Autotest on the patch cords to find one that passes. A PASS* result is sufficient. Select two good patch cords to be your reference patch cords.

Note

When you do the Autotest, keep the patch cord straight as shown in Figure 1 on page 5.

- 5 Save the test results from the reference patch cord, then upload the results to LinkWare. Keep the results where you can find them later.

-continued-

- 6 Mark the reference patch cord ends with “main” and “remote” as it was connected for the test. Keep the reference patch cord to use later for performance tests on the adapters.

 **Caution**

For consistent return loss measurements from the reference patch cord, do not put mechanical stress on the cord during tests or storage. Patch cord performance can change when you bend or twist the cord.

Note

When you do a test on the reference patch cord later, you will use the same main and remote DSX testers you used for the initial test. The test results include the serial numbers of the testers.

How to Verify the Adapters' Performance

Use this procedure to compare results from the initial characterization test with current results to see if the adapters are operating correctly.

- 1 Use LinkWare to open the results from the initial test on the reference patch cord.
- 2 Get the same main and remote DSX testers you used for the initial test. The serial numbers are in the test results.
- 3 Attach the patch cord adapters to the testers.
- 4 Connect the reference patch cord between the main and remote DSX testers. Make sure to connect the ends of the patch cord to the correct testers.
- 5 On the DSX tester, select the same patch cord test limit you used for the initial test.
- 6 Do an Autotest, then save the results.
- 7 Use the plots on the DSX and in LinkWare to compare the NEXT and RL margins in the areas nearest the limit line. For a good adapter and jack, the old and new NEXT and RL margins should be very similar.

Note

If you replaced the jacks on the adapters, the difference between the old and new margins can be more than 0.5 dB. If the difference is more than a few dB, make sure the new jacks are installed correctly and the adapters show no damage.

- 8** If the old and new margins are not similar, replace the RJ45 jacks on the adapters. See "When to Replace the Jacks in the Adapters" on page 10 for details.
- 9** If you did this procedure to verify the performance of new jacks on the adapters, keep the results as the new characterization results for the adapters.

